

Analog Heat MKII

Stereo Analog Sound Processor



FCC compliance statement

This device complies with part 15 of the FCC rules. Operation is subject to the following two conditions: (1) This device may not cause harmful interference, and (2) this device must accept any interference received, including interference that may cause undesired operation.

NOTE: This equipment has been tested and found to comply with the limits for a Class B digital device, pursuant to Part 15 of the FCC Rules. These limits are designed to provide reasonable protection against harmful interference in a residential installation. This equipment generates, uses and can radiate radio frequency energy and, if not installed and used in accordance with the instructions, may cause harmful interference to radio communications. However, there is no guarantee that interference will not occur in a particular installation. If this equipment does cause harmful interference to radio or television reception, which can be determined by turning the equipment off and on, the user is encouraged to try to correct the interference by one or more of the following measures:

- Reorient or relocate the receiving antenna.
- Increase the separation between the equipment and receiver.
- Connect the equipment into an outlet on a circuit different from that to which the receiver is connected.
- Consult the dealer or an experienced radio/TV technician for help.

Canada

This Class B digital apparatus complies with Canadian ICES-003.
Cet appareil numérique de la classe B est conforme à la norme NMB-003

European Union regulation compliance statement

This product has been tested to comply with the Low Voltage Directive 2014/35/EU and the Electro-magnetic Compatibility Directive 2014/30/EU. The product meets the requirements of RoHS 2 Directive 2011/65/EU.



Your product must be disposed of properly according to local laws and regulations.

Legal disclaimer

The information in this document is subject to change without notice and should not be construed as a commitment by Elektron. Elektron assumes no responsibility for any errors that may appear in this document. Elektron may also make improvements and/or changes in the products and programs described in this document at any time without notice. In no event shall Elektron be liable for any special, indirect, or consequential damages or any damages whatsoever resulting from loss of use, data, or profits, whether in an action of contract, negligence, or other action, arising out of or in connection with the use or performance of this information.

IMPORTANT SAFETY AND MAINTENANCE INSTRUCTIONS

Please read these instructions carefully and follow the operating advice given here.

1. Do not use this unit near water.
2. Never use aggressive cleaners on the casing or the screen. Remove dust, dirt and fingerprints with a soft, dry and non-abrasive cloth. More persistent dirt can be removed with a slightly damp cloth using only water. Disconnect all cables before doing this. Only reconnect them when the product is safely dry.
3. Install by following the manufacturer's instructions. Make sure you place the unit on a stable surface before use.
4. Connect the unit to an easily accessible electrical outlet close to the unit.
5. When transporting the unit, use accessories recommended by the manufacturer or the original box and padding.
6. Do not install near any heat sources such as radiators, heat registers, stoves, or any other equipment (including amplifiers) producing heat.
7. Do not block the ventilation holes located on the bottom of the enclosure of the unit. Make sure there is sufficient air circulation in the room where the unit is kept.
8. This product, in combination with an amplifier and speakers or headphones, is capable of producing sound levels that can cause permanent hearing loss. Do not operate for extended periods of time at a high volume level or at a level that is uncomfortable.
9. Protect the power cord from being walked on or pinched particularly at plugs, convenience receptacles, and the point where they exit from the unit.
10. Use attachments/accessories specified by the manufacturer.
11. Unplug this unit during lightning storms or when it is not used for extended periods of time.
12. Refer all servicing to qualified service technicians. Servicing is required when the unit has been damaged in any way, liquid has been spilled or objects have fallen into the unit, the unit has been exposed to rain or moisture, does not operate normally, or has been dropped.

WARNING

To reduce the risk of fire, electrical shock or product damage:

- Do not expose the unit to rain, moisture, dripping or splashing and also avoid placing objects filled with liquid, such as vases, on the unit.
- Do not expose the unit to direct sunlight, nor use it in ambient temperatures exceeding 35°C as this can lead to malfunction.
- Do not open the casing. There are no user repairable or adjustable parts inside. Leave service and repairs to trained service technicians only.
- Do not exceed the limitations specified in the Electrical specifications.

SAFETY INSTRUCTIONS FOR THE POWER ADAPTER ELEKTRON PSU-3b

- The adapter is not safety grounded and may only be used indoors.
- To ensure sufficient ventilation for the adapter, do not place it in tight spaces. To prevent the risk of electric shock and fire because of overheating, ensure that curtains and other objects do not prevent adapter ventilation.
- Do not expose the power adapter to direct sunlight, nor use it in ambient temperatures exceeding 40°C.
- Connect the adapter to an easily accessible electrical outlet close to the unit.
- The adapter is in standby mode when the power cord is connected. The primary circuit is always active as long as the cord is attached to the power outlet. Pull out the power cord to completely disconnect the adapter.
- In the EU, only use CE approved power cords.

TABLE OF CONTENTS

1. INTRODUCTION	7
1.1 CONVENTIONS IN THIS MANUAL	7
2. PANEL LAYOUT AND CONNECTIONS	8
2.1 FRONT PANEL CONTROLS	8
2.2 REAR PANEL CONNECTIONS	9
3. FIRST STEPS WITH THE ANALOG HEAT MKII	10
3.1 CONNECTING THE UNIT.....	10
3.2 SETTING THE INPUT SENSITIVITY LEVEL	10
3.3 SETUP EXAMPLES	11
3.3.1 ANALOG HEAT MKII AS AN EXTERNAL EFFECT	11
3.3.2 ANALOG HEAT MKII AS A VST/AU PLUGIN USING OVERBRIDGE	11
3.3.3 ANALOG HEAT MKII AS A SOUND CARD	11
4. SIGNAL FLOW	12
4.1 AUDIO SIGNAL FLOW	12
4.2 MODULATION SIGNAL FLOW	12
5. THE USER INTERFACE	12
5.1 PRESETS	12
5.1.1 LOADING A PRESET	12
5.1.2 SAVING A PRESET	13
5.2 ACTIVE MODE	13
5.3 EFFECT CIRCUITS.....	13
5.4 FILTER TYPES.....	13
5.5 EQUALIZER	13
5.6 DRIVE	14
5.7 WET LEVEL.....	14
5.8 DRY/WET	14
5.9 SETTINGS MENU	14
5.10 PARAMETER PAGES	14
5.11 PARAMETER EDITING.....	14
5.12 SCREEN INFORMATION	14
5.13 OVERBRIDGE.....	15
6. THE SETTINGS MENU	16
6.1 INPUT SENSITIVITY	16
6.2 MODULATION	16
6.3 OPTIONS.....	16
6.3.1 INTERNAL TEMPO	17
6.3.2 ACTIVE AT START	17
6.3.3 ANALOG IN/OUT	17
6.3.4 KNOB MODE.....	17
6.4 CONTROL IN	18
6.4.1 CONTROL IN A.....	18
6.4.2 CONTROL IN B.....	18
6.5 MIDI.....	18
6.5.1 SYNC.....	18
6.5.2 PORT CONFIG	19
6.5.3 CHANNELS	19

6.6 SYSTEM	20
6.6.1 USB CONFIG.....	20
6.6.2 USB AUDIO CONFIG.....	20
6.6.3 OS UPGRADE.....	20
6.6.4 CALIBRATION.....	20
7. PARAMETER PAGES	21
7.1 AMP PAGE	21
7.1.1 DRIVE.....	21
7.1.2 WET.....	21
7.1.3 DRY/WET.....	21
7.1.4 VOL.....	21
7.2 FILTER & EQ PAGE 1	21
7.2.1 FREQ.....	21
7.2.2 RESO.....	21
7.2.3 ENV.....	21
7.2.4 LFO.....	21
7.3 FILTER & EQ PAGE 2	22
7.3.1 FRQPAN.....	22
7.3.2 DIRT.....	22
7.3.3 EQ LO.....	22
7.3.4 EQ HI.....	22
7.4 ENVELOPE PAGE 1	22
7.4.1 MODE.....	22
7.4.2 ATK.....	23
7.4.3 REL.....	23
7.4.4 TRIG.....	24
7.5 ENVELOPE PAGE 2	24
7.5.1 BASE.....	24
7.5.2 WIDTH.....	24
7.5.3 DEST1.....	24
7.5.4 DEPTH1.....	25
7.6 LFO PAGE 1	25
7.6.1 SPEED.....	25
7.6.2 MULT.....	25
7.6.3 WAVE.....	25
7.6.4 START.....	25
7.7 LFO PAGE 2	25
7.7.1 FADE.....	26
7.7.2 MODE.....	26
7.7.3 DEST1.....	26
7.7.4 DEPTH1.....	26
8. TIPS & TRICKS	27
8.1 ADDING SATURATION TO THE HIGH REGISTER	27
8.2 PSEUDO-COMPRESSION	27
8.3 STEREO PHASER EFFECT	28
9. STARTUP MENU	29
9.1 TEST MODE	29
9.2 EMPTY RESET	29
9.3 FACTORY RESET	29
9.4 OS UPGRADE	29

TABLE OF CONTENTS

10. TECHNICAL INFORMATION.....30
11. CREDITS AND CONTACT INFORMATION.....30
APPENDIX A: MIDI..... 31
APPENDIX B: MODULATION SOURCES AND DESTINATIONS32
INDEX.....33

1. INTRODUCTION

Thank you for purchasing Analog Heat MKII. The Analog Heat MKII is a stereo analog sound processor with many great features such as; 8 different analog effect circuits, an analog multimode filter, analog EQ, and support for Elektron's groundbreaking software suite Overbridge.

Its innovative combination of modern technology and tried and trusted ways of analog sound processing lets you add sparkly brilliance, or grimy roughness, to any sound source. This updated version of the Analog Heat features a new and bigger OLED screen, ultra-durable backlit buttons, and improved hi-resolution encoders.

We wish you a happy analog experience. Have fun!

- The Elektron Team

1.1 CONVENTIONS IN THIS MANUAL

We have used the following conventions throughout the manual:

- **KEY NAMES**
Written in uppercase, bold style and within brackets. For example, the key labeled "YES" is called **[YES]**.
- **KNOBS**
Written in uppercase, bold, italic letters. For example, the knob "Preset/Data" is called ***PRESET/DATA***.
- **LED INDICATORS**
Written in uppercase letters with angle brackets. For example, the pattern page LEDs are called: **<FILTER TYPE>**.
- **MENU NAMES**
Written in uppercase letters. For example, the SETTINGS menu.
- **PARAMETER NAMES, MENU OPTIONS**
Written in uppercase bold letters for parameter names and certain menu options where you can make settings or perform actions. For example, **ATTACK**.
- **PARAMETER SETTING ALTERNATIVES**
Written in uppercase letters. For example, OFF.
- **SCREEN MESSAGES**
Written in uppercase letters with quotation marks. For example, "INPUT LEVEL TOO HIGH!"

The manual uses the following symbols:



Important information that you should pay attention to.



A tip that makes it easier for you to interact with Analog Heat MKII.

2. PANEL LAYOUT AND CONNECTIONS

2.1 FRONT PANEL CONTROLS

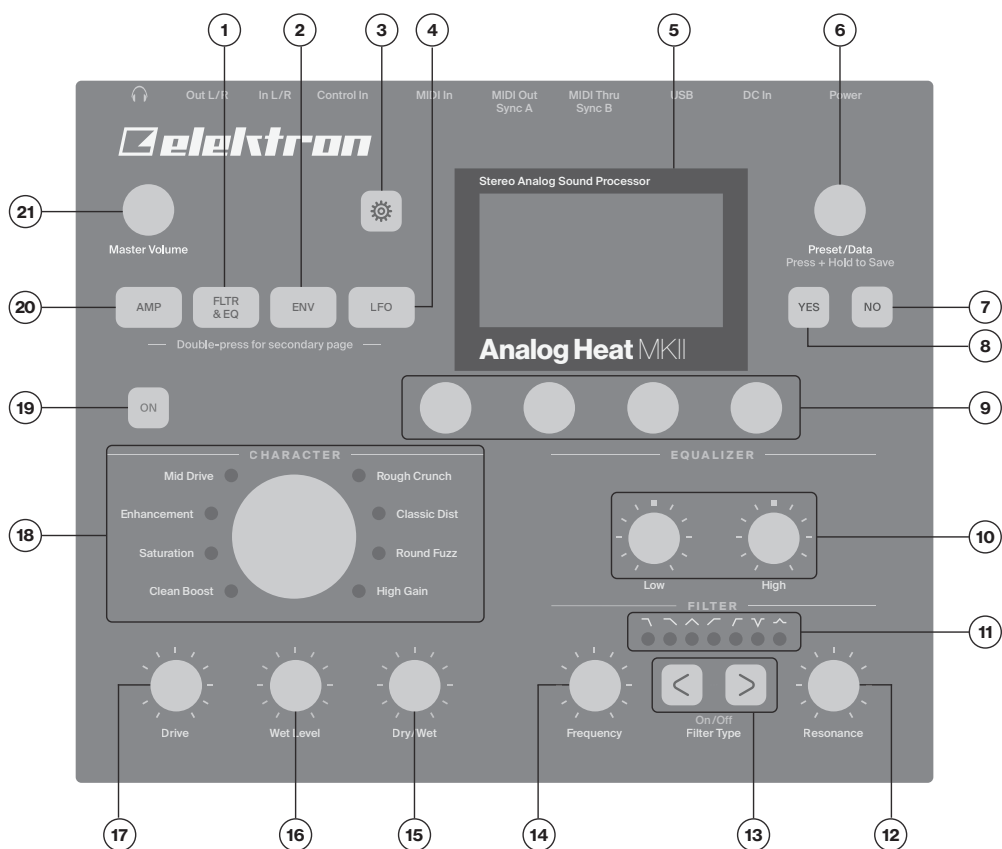

1. **[FLTR & EQ]** key accesses the FILTER and EQ parameter pages where you, among other things, can select filter types and adjust the equalizer. Press twice to access the secondary page.
2. **[ENV]** key accesses the ENV parameter pages where you adjust the settings for the envelope generator/envelope follower. Press twice to access the secondary page.
3. **[LFO]** key accesses the LFO parameter pages where you set all things related to the Low-Frequency Oscillator. Press twice to access the secondary page.
4. **[SETTINGS]**  key accesses the SETTINGS menu. Contains both global settings and preset settings.
5. Screen.
6. **PRESET/DATA** Used for preset management and data entry.
7. **[NO]** key is used for exiting the current menu, backing to a higher level menu and negating.
8. **[YES]** key is used for entering sub-menus, selecting and confirming.
9. **DATA ENTRY** knobs. Used to set parameter values.
10. **LOW** and **HIGH** adjust the amount of low-end and high-end frequency content.
11. <FILTER TYPE> LEDs that indicate the current type of filter and also if the filter is on or not.
12. **RESONANCE** sets the resonance of the filter.
13. **[FILTER TYPE]** selects between the different filter types. Also, pressing both keys at the same time toggles the filter on and off.
14. **FREQUENCY** sets the filter's cutoff frequency.
15. **DRY/WET** sets the balance between the unprocessed (dry) signal and the processed (wet) signal.
16. **WET LEVEL** sets the level of the processed (wet) signal.
17. **DRIVE** controls the amount of drive. This parameter increases the effect of the selected circuit type.
18. **CIRCUIT SELECTOR** chooses between the eight different types of effect circuits.
19. **[ON]** toggles the effect between active and bypassed.
20. **[AMP]** key accesses the AMP parameter page where you can set things such as drive amount and the volume of the preset.
21. **MASTER VOLUME** sets the master volume for the L/R and Headphones outputs.

2.2 REAR PANEL CONNECTIONS

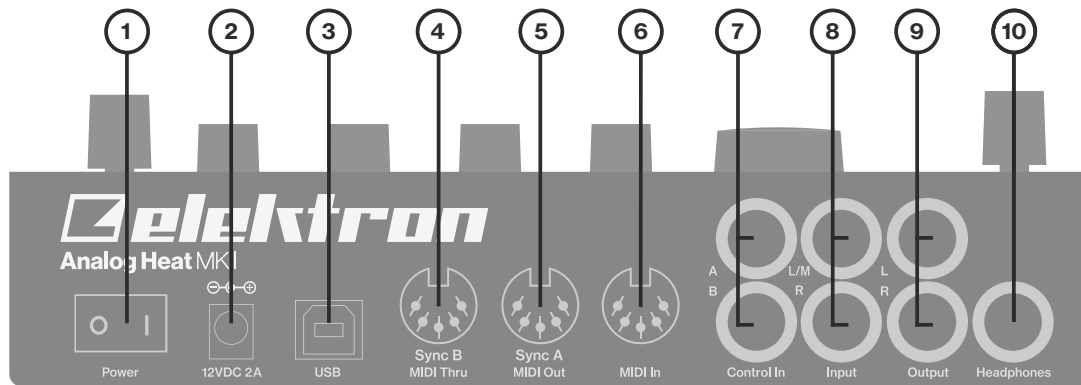

1. **POWER**, Switch for turning the unit on and off.
2. **DC IN**, Input for power supply. Use the included PSU-3b power adapter connected to a power outlet.
3. **USB**, For connecting the unit to a computer. Used for MIDI control or Overbridge. Connect to a computer host using the included A to B USB 2.0 connector cable.
4. **MIDI THRU/SYNC B**, Forwards data from MIDI IN. Can also be configured to send DIN sync to legacy instruments. Use a standard MIDI cable to connect another MIDI unit in the chain.
5. **MIDI OUT/SYNC A**, MIDI data output. Can also be configured to send DIN sync to legacy instruments. Use a standard MIDI cable to connect to MIDI In of an external MIDI unit.
6. **MIDI IN**, MIDI data input. Use a standard MIDI cable to connect to MIDI Out of an external MIDI unit.
7. **CONTROL IN A/B** Inputs for an expression pedal, footswitch, or CV. Use 1/4" mono phone plug for CV signals.
8. **INPUT L (mono)/R**, Audio inputs. Use either 1/4" mono phone plug (unbalanced connection) or 1/4" (Tip/Ring/Sleeve) phone plug (balanced connection).
9. **OUTPUT L/R**, Main audio outputs. Use either 1/4" mono phone plug (unbalanced connection) or 1/4" (Tip/Ring/Sleeve) phone plug (balanced connection).
10. **HEADPHONES**, Audio output for stereo headphones. Use 1/4" (Tip/Ring/Sleeve) phone plug.

3. FIRST STEPS WITH THE ANALOG HEAT MKII

3.1 CONNECTING THE UNIT

Make sure you place the Analog Heat MKII on a stable support, such as a sturdy table with sufficient cable space. Before you start connecting the Analog Heat MKII to other units, make sure all units are switched off.

1. Plug the supplied DC adapter to a power outlet and connect the small plug to the 12 V DC connector of the Analog Heat MKII unit.
2. Connect the audio source to INPUT L/R.
3. Connect the OUTPUT L/R from the Analog Heat MKII to your mixer or amplifier.
4. To process sound or control the Analog Heat MKII from a computer, connect a USB cable between the computer and the USB connector of the Analog Heat MKII. You must also download and install the Overbridge Suite to perform these actions.
5. If you want to use MIDI to control the Analog Heat MKII, connect the MIDI OUT port of the device you wish to send data from to the MIDI IN port of the Analog Heat MKII. The MIDI THRU port duplicates the data arriving at the MIDI IN port, so you can use it for chaining MIDI units together.
6. Switch on all units. Press the power switch located at the back of the Analog Heat MKII to switch it on.

3.2 SETTING THE INPUT SENSITIVITY LEVEL



To make sure the Heat distorts as intended it is important to adjust the audio input sensitivity level so that it matches the level of the sound source.

To make sure the Heat distorts as intended it is essential to set the audio input sensitivity so that it matches the level of the sound source. (Note that the settings made here only affects the analog input and not the digital input from Overbridge.) Use the audio input meter on the screen to monitor your audio input level and follow these steps to set the input sensitivity level:

1. Connect your sound source to the IN L/R inputs of the Analog Heat MKII and make sure that the volume of the sound source is as loud as possible.
2. Press **[SETTINGS]** and select INPUT SENSITIVITY. Keep an eye on the audio input meter and change the input sensitivity until you find a setting where the bar reaches the vertical line but without clipping. The message "INPUT LEVEL TOO HIGH" is displayed on the screen when the input level is too high, and clipping occurs.



Optimal input level.

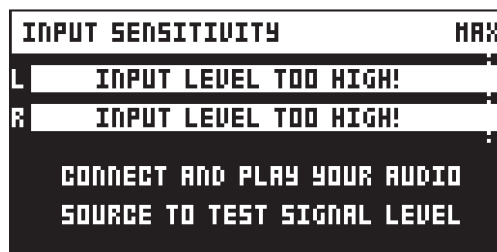

Too high input level.

3. Adjust the level at the sound source if needed.

3.3 SETUP EXAMPLES

The Analog Heat MKII is very well suited for use in both an analog setup and in a more digital environment. Here are a couple of examples of how you can use the Analog Heat MKII. For more information about how to set up Analog Heat MKII in different configurations, please see "6.3.3 ANALOG IN/OUT" on page 17.

3.3.1 ANALOG HEAT MKII AS AN EXTERNAL EFFECT

In this example, the Analog Heat MKII is used as an external effect to add color to the Elektron Octatrack before the signal reaches the mixer.



3.3.2 ANALOG HEAT MKII AS A VST/AU PLUGIN USING OVERBRIDGE

Analog Heat MKII can also be used together with Overbridge to allow you to use the Analog Heat MKII as a plug-in for analog distortion processing in your DAW.

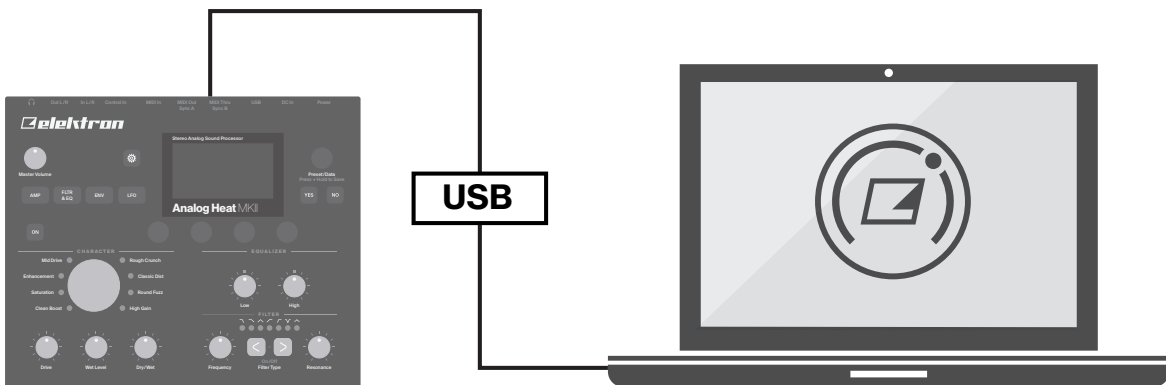

3.3.3 ANALOG HEAT MKII AS A SOUND CARD

Analog Heat MKII also functions as a 2 in/2 out sound card for your computer and can be used for both recording and monitoring audio. At the same time you can, via Overbridge, use the effect to process another set of audio signals.

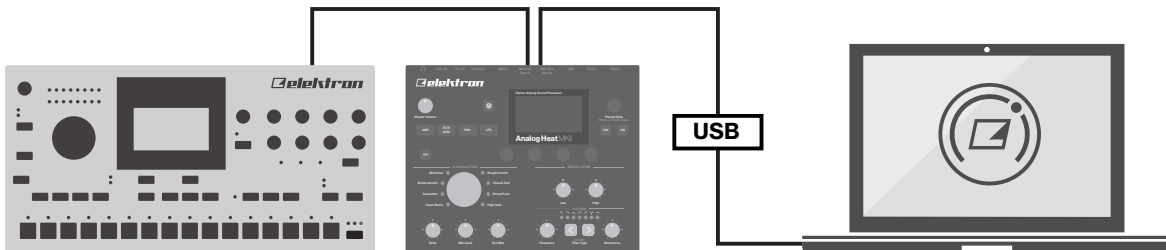

4. SIGNAL FLOW

The illustrations below show the signal flows of the Analog Heat MKII and illustrates how the different components interact with each other.

4.1 AUDIO SIGNAL FLOW

This illustration shows the general flow of audio through the Analog Heat MKII. The complete signal chain is in stereo.

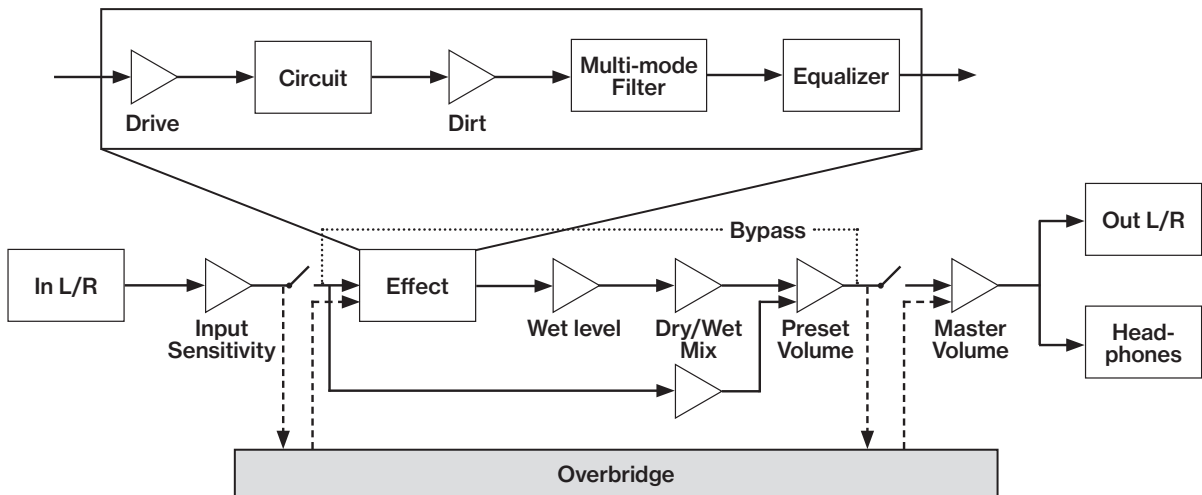

4.2 MODULATION SIGNAL FLOW

This illustration shows the flow of how modulation signals are generated and routed through the Analog Heat MKII.

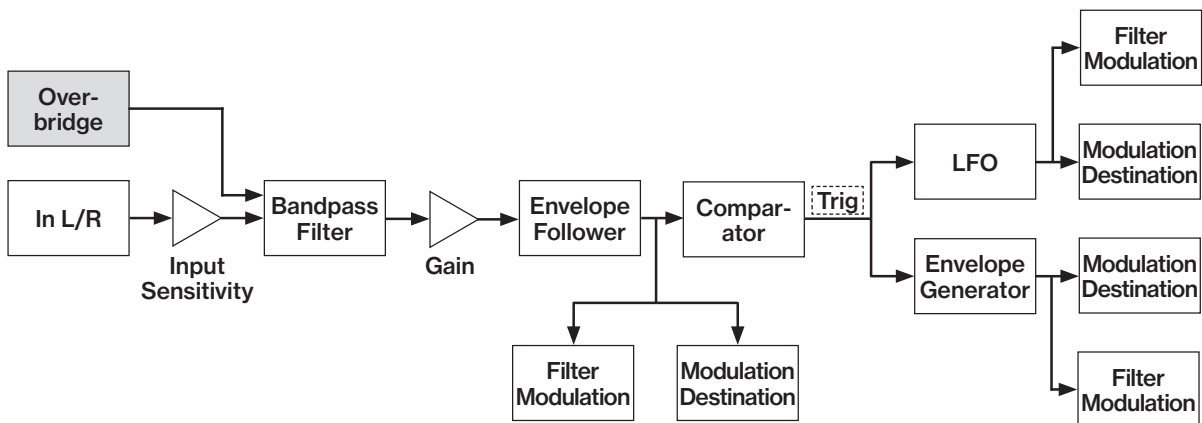

5. THE USER INTERFACE

5.1 PRESETS

The Analog Heat MKII has 128 preset slots where you can store your presets. Preset slot 000 is an INIT preset with default values. Note that, when switching off the power on your Heat, any changes to the currently active preset will be lost unless the preset is first saved. There is an indicator (next to the preset number) on the LCD screen showing when changes have been made to the preset. For more information, please see "5.12 SCREEN INFORMATION" on page 14.

5.1.1 LOADING A PRESET

1. Turn **PRESET/DATA** to select a preset.
2. Press **PRESET/DATA** or **[YES]** to load the preset.

5.1.2 SAVING A PRESET

1. Press and hold **PRESET/DATA** for two seconds. The selected preset now starts to blink to illustrate that you are about to overwrite a preset position.
2. Turn **PRESET/DATA** to select the preset slot to where you want to save your sound, and then press **[YES]**.
3. (Optional) Turn **PRESET/DATA** to the character you wish to edit. Press and hold **[SETTINGS]** and then turn **PRESET/DATA** to move the cursor to the desired character and select it by releasing **[SETTINGS]**. To delete a character, turn **PRESET/DATA** to move the cursor to highlight the character after the one you wish to delete, then press and hold **[SETTINGS]** and press **[NO]** twice.
4. Press **[YES]** to save the preset.

5.2 ACTIVE MODE

When you set the Active Mode to ON, the Analog Heat MKII affects the incoming signal. Active Mode is toggled on and off by pressing **[ON]**. The light of the **[ON]** key indicates if the effect is active or not. You can also use a Footswitch to toggle the Active Mode. For more information, please see "6.4 CONTROL IN" on page 18. You also have the option to set if you want the Analog Heat MKII to start in active mode or not when you turn it on. For more information, please see "6.3.2 ACTIVE AT START" on page 17. Turn Active Mode OFF to bypass the effect.

5.3 EFFECT CIRCUITS

You can use the **CIRCUIT SELECTOR** to choose between 8 different types of effect circuits for a wide variety of drive and distortion sounds.

- **CLEAN BOOST**
Makes the signal louder. When fully driven, it sounds similar to overdriving old mixers. Use for minimal distortion or when you only want to use the filter and EQ.
- **SATURATION**
This circuit is reminiscent of classic tape saturation. Woolly and warm.
- **ENHANCEMENT**
Adding tube-like glow and sheen to a track or loop.
- **MID DRIVE**
Mid-range focused overdrive with a solid and distinct body.
- **ROUGH CRUNCH**
Gritty, worn and gnarly character. Full of flavor.
- **CLASSIC DIST**
Pleasantly distorts upper mid-range frequencies. Ideal for acid bass lines.
- **ROUND FUZZ**
Adds a lot of harmonics and alters the signal in interesting and often unpredictable ways.
- **HIGH GAIN**
Probably the most aggressive of all the circuits. Very maxed out!

5.4 FILTER TYPES

Change the type of the filter by pressing one of the two **[FILTER TYPE]** keys. You can also press the two **[FILTER TYPE]** keys simultaneously to toggle the filter on/off. It is possible to change the filter type even if the filter is turned off.

There are seven different analog filter types in the Analog Heat MKII to help to shape the sound.

- **LOW PASS 2** (two-pole, 12 dB per octave)
- **LOW PASS 1** (one-pole, 6 dB per octave)
- **BAND PASS**
- **HIGH PASS 1** (one-pole, 6 dB per octave)
- **HIGH PASS 2** (two-pole, 12 dB per octave)
- **BAND STOP (NOTCH)**
- **PEAK**

5.5 EQUALIZER

LOW and **HIGH** adjust the amount of low-end and high-end frequency gain or attenuation of the effect circuit. Each character circuit comes with its tailor-made equalizer characteristics. For more information, please see "4.1 AUDIO SIGNAL FLOW" on page 12.

5.6 DRIVE

DRIVE sets the gain level in the effect circuit. A higher setting increases the effect of the selected circuit type, typically resulting in more distortion. For more information, please see "4. SIGNAL FLOW" on page 12.

5.7 WET LEVEL

WET LEVEL sets the level of the signal coming from the effect. It is applied before the DRY/WET mix. It is used to match the level of the dry signal for easy mixing of the two. For more information, please see "4. SIGNAL FLOW" on page 12.

5.8 DRY/WET

DRY/WET sets the mix between the clean signal and the signal that is affected by the effect. For more information, please see "4. SIGNAL FLOW" on page 12.

5.9 SETTINGS MENU

Press [SETTINGS] to access the SETTINGS menu.

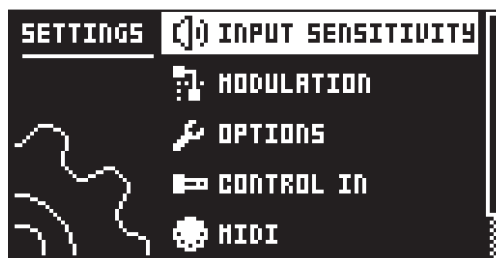

Scroll through the list of settings by using the **PRESET/DATA** knob. Open a highlighted menu by pressing the **PRESET/DATA** knob or [YES]. To change the settings in the menus, first press, and then turn the **PRESET/DATA** knob. For more information, please see "6. THE SETTINGS MENU" on page 16.

5.10 PARAMETER PAGES

Access the parameter pages by pressing the corresponding key [AMP], [FLTR & EQ], [ENV], and [LFO]. There are two pages associated with each key (AMP has only one page). You can access the secondary pages by pressing the [PARAMETER] key a second time. For more information, please see "7. PARAMETER PAGES" on page 21.

5.11 PARAMETER EDITING

The four **DATA ENTRY** knobs are used to change the parameter values that you see on the screen. (Some parameters also have dedicated knobs on the panel.) The physical location of the knobs on the front panel corresponds to the layout of the parameters on the screen.

- Press down and turn the **DATA ENTRY** to adjust the parameters in larger increments.
- Press [SETTINGS] + turn **DATA ENTRY** knob to quantize the parameter value to integers.
- Press [NO] + **DATA ENTRY** knob to reset the parameter to the default value.
- Press [NO] + [PARAMETER] key to reset the selected parameter group to default values.
- Use the [NO] key to exit an active menu, back to a higher level menu and to negate.

5.12 SCREEN INFORMATION

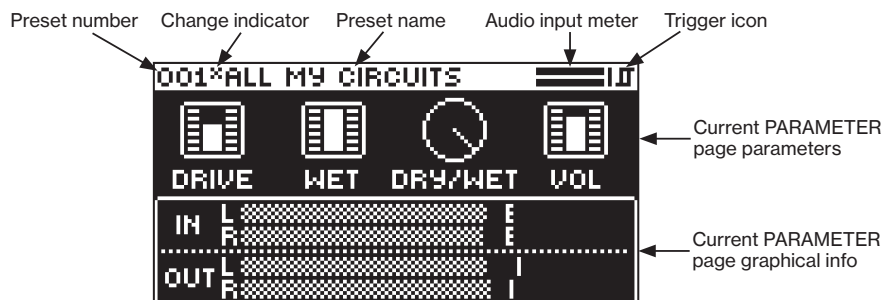

- The Preset number and Preset name display the currently selected preset. If you push one of the parameter keys, the title bar briefly shows the name of the active parameter page. This text is replaced by parameter names when turning the **DATA ENTRY** knobs or the dedicated controllers.
- Between the preset number and the preset name, there is an indicator that shows if the preset is altered, (contain changes that will be lost unless you save the preset.)
- The Audio input meter displays the level of the incoming audio.
- The Trigger icon shows that the Envelope Follower, an external gate signal or manual triggering has generated a trigger event.
- The PARAMETER page parameters show what the **DATA ENTRY** knobs control and their current parameter values.
- The graphical information varies depending on the current PARAMETER page.

5.13 OVERBRIDGE

The Overbridge software suite enables a tight integration between the Analog Heat MKII and a computer DAW software.

When using Overbridge, the user interface for the Analog Heat MKII presents itself as a plug-in window in your DAW. Access, edit and automate parameters for sound shaping on screen. Always find your device preset parameters in the same state as you left them when you return to your DAW project, with the useful total recall functionality.

Read more about Overbridge use and availability on the Elektron website: <https://www.elektron.se/overbridge/>

6. THE SETTINGS MENU

Here follows a description of all the parameters that are in the SETTINGS menu. You access the SETTINGS menu by pressing the [SETTINGS] key. Scroll through the list of settings by using the **PRESET/DATA** knob. Open a highlighted menu by pressing the **PRESET/DATA** knob or [YES]. To change the settings in the menus, first press and then turn the **PRESET/DATA** knob.

6.1 INPUT SENSITIVITY



Sets the audio input level to fit the audio level sent to the effect via the **IN L/R** inputs. It is important to set this level correctly to get the best sound from your Analog Heat MKII. There are four different settings for the input sensitivity: LOW, MID, HIGH & MAX. Low is the most silent, Max is the loudest. For more information, please see "3.2 SETTING THE INPUT SENSITIVITY LEVEL" on page 10.

- **LOW** (Maximum input level 10,5 V, peak to peak)
- **MID** (Maximum input level 5,3 V, peak to peak)
- **HIGH** (Maximum input level 2,5 V, peak to peak)
- **MAX** (Maximum input level 1,2 V, peak to peak)

6.2 MODULATION

SOURCE	DEST	DEPTH
ENV 1st	none	
ENV 2nd	WDR	
LFO 1st	Wet Level	
LFO 2nd	Dry/Wet Mix	
CV In A	Preset Vol	22.06
CV In B	EQ Low	
EXPR PED A	EQ High	
EXPR PED B	Filter Freq	

Here you can connect a number of modulation sources with their destinations and set the modulation depth. For more information, please see "APPENDIX B: MODULATION SOURCES AND DESTINATIONS" on page 32.

1. Turn the **PRESET/DATA** knob to scroll through the source list, and then select it by pressing **PRESET/DATA** or [YES].
2. Turn the **PRESET/DATA** knob to scroll through the available destinations, and then select it by pressing **PRESET/DATA** or [YES].
3. Lastly, set the modulation depth amount by turning the **PRESET/DATA** knob. A negative value gives an inverted modulation. You can also use the rightmost **DATA ENTRY** knob to set the modulation depth. To reset the modulation amount to 0, press and hold [NO].

6.3 OPTIONS

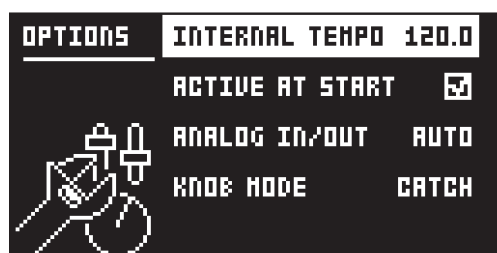

6.3.1 INTERNAL TEMPO

Sets the internal tempo. The tempo range is 30 – 300 BPM. This tempo controls the speed of the LFO. The Analog Heat MKII can also be set to respond to MIDI clock sent from external devices. If the device is synced from either MIDI Clock or Overbridge, the Internal Tempo setting is locked from editing, and this parameter instead shows the sync source together with the currently active (external) tempo. For more information, please see "6.5.1 SYNC" on page 18.

6.3.2 ACTIVE AT START

Sets if Analog Heat MKII is in Active Mode or not when it is turned on.

6.3.3 ANALOG IN/OUT

Sets if the signal from the analog inputs is routed to the effect or not. It also sets if the signal from the effect is routed analog outputs or not.

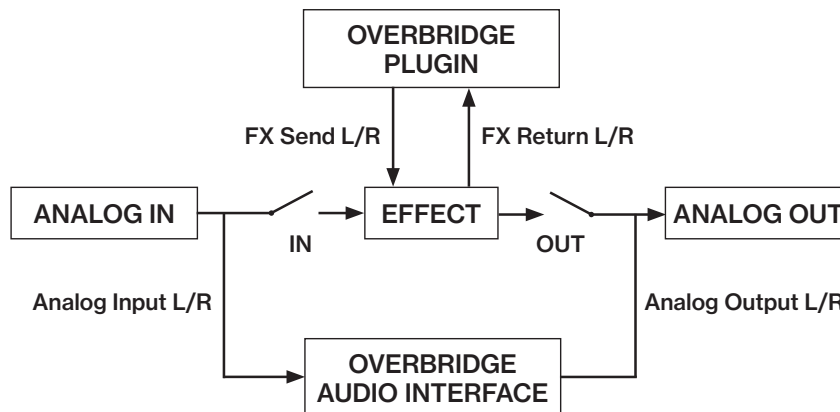

Analog Heat MKII supports 4 channels of audio. Analog Input L/R are routed to the analog in-, and out-, and can optionally also be routed through the effect. FX Send L/R are always routed to the effect.

- **AUTO** In Auto mode, Analog Heat MKII automatically detects if the Overbridge plugin is running or not. With Overbridge running, the Analog In is not routed through the effect to the Analog Out. (Same as **OFF** setting.) If Overbridge is not running, the signal from analog is routed through the effect to the Analog Out. (Same as **IN+OUT** setting.)
- **IN+OUT** Both Analog In and Analog Out are routed to the effect.
- **IN** Routes the signal from Analog In to the effect.
- **OUT** Routes the signal from the effect to Analog Out.
- **OFF** Neither Analog In nor Analog Out are routed to the effect.



You can use the Analog Heat MKII as a regular audio interface and let signals pass in and out unaffected by the effect. At the same time you can, via Overbridge, also use the effect to process another set of audio signals.

AUTO mode is suitable for most use-cases. It lets the Analog Heat MKII function both as a standalone effect and together with Overbridge as a plugin, while still retaining its functionality as a sound card.

6.3.4 KNOB MODE

Sets how the knobs on the panel affect the parameters. When you load a preset, the knobs positions typically don't match their parameter values.

- **JUMP** immediately sets the value to the current knob position.
- In **CATCH** mode, turning the knob do not change the parameter value until the knob position matches the presets stored value.

You can see the current value of the parameter in the screens title bar while you turn the knob.

6.4 CONTROL IN

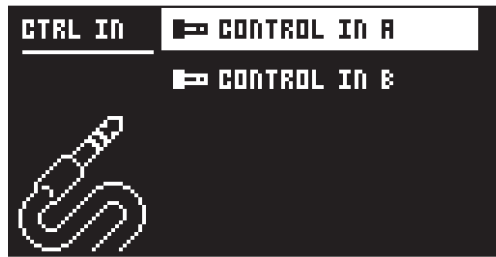

6.4.1 CONTROL IN A

- **CONTROL MODE**
Sets the port mode to adjust to different kinds of input signals. There are four modes: **CV** (Control Voltage), **EXPR** (Expression Pedal), **FOOTSW** (Footswitch) and **OFF**.
- **CV ZERO LEVEL (Available when mode is set to CV.)**
Sets the Volt level at which CV modulation amount is zero. A control input level equal to this setting corresponds to zero modulation. (-5.50 V–+5.50 V).
- **CV MAX LEVEL (Available when mode is set to CV.)**
Sets the Volt level at which CV modulation amount is max. A control input level equal to this setting corresponds to full modulation. (-5.50 V–+5.50 V).
- **EXPRESSION LEARN (Available when mode is set to EXPR.)**
Sets the highest and lowest limit of the control input level. When in this setting, connect the Expression pedal to CONTROL IN A/B. Press YES and then move the expression pedal first to max and then to min position. Press YES to save settings.
- **REVERSE DIRECTION (Available when mode is set to EXPR.)**
Reverses the direction of how the Expression pedal sends control input signals.
- **FOOTSW DEST (Available when mode is set to FOOTSW.)**
Sets the destination of the control input from the Footswitch. The options are: TEMPO, ACTIVE PRESET +, PRESET -, ENV TRIG
- **FOOTSWITCH LEARN (Available when mode is set to FOOTSW.)**
Sets the high and low limit of the control input level. When in this setting, connect the Footswitch pedal to CONTROL IN A/B. Press YES and then press the Footswitch pedal a couple of times. Press YES to save settings.
- **REVERSE DIRECTION (Available when mode is set to FOOTSW.)**
Reverses the direction of how the Footswitch pedal sends control input signals.

6.4.2 CONTROL IN B

The available settings are the same as for **CONTROL IN A** mentioned above.



If you set **CONTROL MODE** to **FOOTSW** you can send a gate signal to the Control In inputs to trigger the envelope generator. For more information, please see "7.4 ENVELOPE PAGE 1" on page 22.

6.5 MIDI

These settings are stored in the global settings and are not part of the preset.



6.5.1 SYNC

- **CLOCK RECEIVE**
Sets whether or not the Analog Heat MKII responds to MIDI clock and transport sent from external devices. (ON, OFF)

- **CLOCK SEND**
Sets whether or not the Analog Heat MKII sends/forwards MIDI Clock and transport. Transport is transmitted when an external clock source (MIDI or Overbridge) is used. (ON, OFF)
- **PROG CHG RECEIVE**
Sets whether or not the Analog Heat MKII responds to incoming program change messages. This is useful when wanting to select presets from an external source. For more information on how to select the appropriate MIDI channel, please see "6.5.3 CHANNELS" on page 19. (ON, OFF)
- **PROG CHG SND**
Sets whether or not the Analog Heat MKII sends program change messages when it changes patches. For more information on how to select the appropriate MIDI channel, please see "6.5.3 CHANNELS" on page 19. (ON, OFF)

6.5.2 PORT CONFIG

- **TURBO SPEED**
This setting allows Turbo mode negotiation between Elektron gear. Connecting the Analog Heat MKII to other Turbo protocol compatible gear, like the Analog Rytm and the Octatrack, makes it possible to increase the average MIDI bandwidth by up to 10x. This increases the accuracy of MIDI clock signals as well as the timing of CC messages. (ON, OFF)
- **OUT PORT FUNC**
Sets what type of signal the MIDI OUT port sends.
 - **MIDI** sets the port to send MIDI data.
 - **DIN24** sets the port to send DIN 24 sync pulses. No MIDI data can be sent on the port when this option is selected.
 - **DIN48** sets the port to send DIN 48 sync pulses. No MIDI data can be sent on the port when this option is selected.
- **THRU PORT FUNC**
Sets what type of signal the MIDI THRU port sends. The settings are the same as for **OUT PORT FUNC**.
- **INPUT FROM**
Sets the source from which the Analog Heat MKII receives MIDI data.
 - **MIDI** Only receives MIDI data from the MIDI IN port.
 - **USB** Only receives MIDI data from the USB port.
 - **MIDI+USB** Receives MIDI data from both the MIDI IN and USB port.
 - **NONE** Disregards any incoming MIDI data.
- **OUTPUT TO**
Selects the port to which Analog Heat MKII sends MIDI data (CC or NRPN).
 - **MIDI** Only sends MIDI data to the MIDI OUT port.
 - **USB** Only sends MIDI data to the USB port.
 - **MIDI+USB** Sends MIDI data to both the MIDI OUT and USB port.
 - **NONE** Do not send MIDI data to any port.
- **PARAM OUTPUT**
Sets what type of MIDI messages the **DATA ENTRY** knobs sends. For information about which CC/ NRPN parameters that are sent, please see "APPENDIX A: MIDI" on page 31.
 - **CC** Sets the knobs to send CC MIDI messages.
 - **NRPN** Sets the knobs to send NRPN MIDI messages.
- **ENCODER DEST**
Sets whether or not the **DATA ENTRY** and **LEVEL** knobs send MIDI data.
 - **INT** MIDI only sends data internally.
 - **INT + EXT** MIDI sends data both internally and externally.
- **PARAM INPUT**
Makes it possible to control Analog Heat MKII parameters from an external MIDI device sending CC/NRPN data. (ON, OFF)

6.5.3 CHANNELS

- **MIDI CHANNEL**
Sets the MIDI channel that Analog Heat MKII uses to send and receive MIDI data. When set to OFF, all MIDI functionality is disabled. (1-16)

6.6 SYSTEM



6.6.1 USB CONFIG

- **USB-MIDI ONLY**
If you wish to disable the Overbridge integration functionality, then select this option. (ON, OFF)
- **OVERBRIDGE**
To use the Analog Heat MKII as an Overbridge device, select Overbridge mode. (ON, OFF)

6.6.2 USB AUDIO CONFIG

Here you can set the output level of the audio over USB when you use the Analog Heat MKII as a sound card. Select **USB OUTPUT LEV** and set the desired output level. This setting only affects Analog Out L/R (OUTPUT L/R). (0 dB–+18 dB)

6.6.3 OS UPGRADE

This menu option is used to upgrade the Analog Heat MKII OS. To send the OS syx file, use our free SysEx utility software C6 (or other compatible SysEx software). You can download the OS syx file and the C6 software from the Elektron website.

For the transfer to be possible, the device sending the OS syx-file must be connected to either the MIDI IN or USB port of the Analog Heat MKII. Also, input from MIDI or USB must be enabled on the Analog Heat MKII. For more information, please see "6.5.2 PORT CONFIG" on page 19.



Please note that the Analog Heat MKII do not appear as an icon on your computer desktop.

1. Download the OS syx file and the C6 software to your computer.
2. Select **OS UPGRADE** on the Analog Heat MKII (If you wish to cancel the waiting state, press **[NO]**.)
3. Open the C6 software. Click "Configure" and select Elektron Analog Heat MKII for MIDI In as well as MIDI Out.
4. Drag the OS syx file to the C6 main window, then highlight it by single-clicking it.
5. Click the "send" button in the top left corner of the C6 window.

When receiving the OS, a progress bar and the message "RECEIVING" is visible on the Analog Heat MKII screen. When the bar is full, the message "ERASING FLASH" is shown on the screen. This takes a short while. When this process is complete, the OS is updated, and the unit reboots.

6.6.4 CALIBRATION

CALIBRATION starts the calibration routine for the drive circuits and filters. After selecting this option, a popup window appears asking to confirm the calibration. Press **[YES]** to proceed with the calibration. Please note that the calibration routine takes quite a while to complete.



The device should be turned on for at least 2 hours before you perform a calibration for its circuits to warm up properly. If the unit has not yet warmed up for 2 hours, there is a calibration countdown counter which automatically initiates the calibration once it reaches the timeout.

Also, please note that nothing should be connected to the device during the calibration.

Analog Heat MKII is factory calibrated. It should not be re-calibrated unless specifically stated by Elektron Support or if prompted by the machine.

7. PARAMETER PAGES

Here follows a description of all the parameters that are on the PARAMETER pages. You access the parameter pages by pressing the [PARAMETER] keys. **AMP** has one page. **FILTER/EQ**, **ENV**, and **LFO** has two pages. To access page one, press the [PARAMETER] key once. To access page two, press the [PARAMETER] key twice.

7.1 AMP PAGE

Press [AMP] once to access this parameter page.

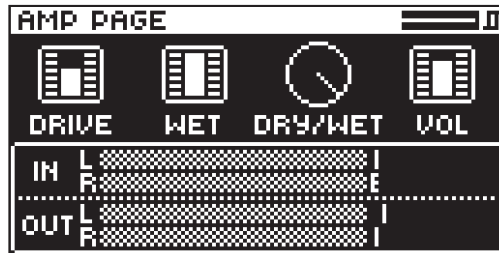

7.1.1 DRIVE

Sets the gain level of the audio into the distortion circuit. A higher setting results in more distortion. Even at zero level some of the circuits have a clear effect on the sound. (0.00–127.00)

7.1.2 WET

Sets the level of the signal that is affected by the effect. Use WET LEVEL to balance the Wet part so that it has a similar level to the Dry part. This makes it easier to use the (Dry/Wet) MIX parameter to do parallel distortion. For more information, please see "4. SIGNAL FLOW" on page 12. (This parameter is written as *WET LEVEL* on the device panel.) (0.00–127.00)

7.1.3 DRY/WET

Sets the mix between the clean signal and the signal that is affected by the effect. (-64.00–63.00)

7.1.4 VOL

Sets the overall level of the sound and is saved as part of the preset. Use this to pick a good output gain for the complete preset (i.e. from the output of the Dry/Wet mix). (0–127)

7.2 FILTER & EQ PAGE 1

Press [FLTR & EQ] once to access this parameter page.

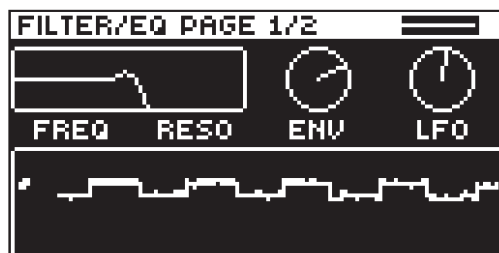

7.2.1 FREQ

Sets the cutoff frequency of the filter. (0.00–127.00)

7.2.2 RESO

Sets the amount of resonance at the cutoff point of the filter. (0.00–127.00)

7.2.3 ENV

Sets the amount of how much the envelope and envelope follower affects the filter frequency. A negative value gives an inverted modulation. (-128.00–127.00)

7.2.4 LFO

Sets the amount of how much the LFO affects the filter frequency. A negative value gives an inverted modulation. (-128.00–127.00)

7.3 FILTER & EQ PAGE 2

Press [FLTR & EQ] twice to access this parameter page.



7.3.1 FRQ PAN

Adjust the cutoff frequency of the filter and pans its behavior between the Left and Right channel. At a value of 0 there is no frequency panning effect. Lower values increase the cutoff frequency in the Left channel and decrease it in the Right channel. Higher values increase the cutoff frequency in the Right channel and decrease it in the Left channel. (-64.00–63.00)

7.3.2 DIRT

This parameter sets the amount of input level to the filter. It can be used to slightly overdrive the signal going into the filter, producing filter distortion. (0–127)

7.3.3 EQ LO

Controls the amount of low-end in the equalizer. Depending on selected circuit-type, this affects the low-end in slightly different ways, always tailor-made to suit the characteristics of the selected circuit. (-64.00–63.00)

7.3.4 EQ HI

Controls the amount of high-end in the equalizer. Depending on selected circuit-type, this affects the high-end in slightly different ways, always tailor-made to suit the characteristics of the selected circuit. (-64.00–63.00)

7.4 ENVELOPE PAGE 1

Press [ENV] once to access this parameter page.

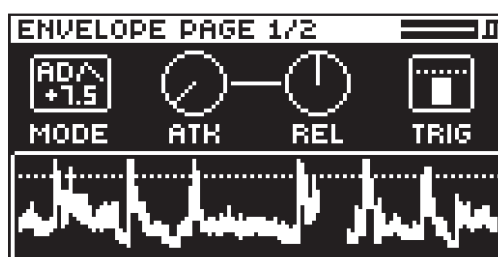

Analog Heat MKII contains an envelope follower function. The envelope follower is used to detect the amplitude variations of the incoming audio signal to produce a control signal (envelope) that resembles those variations. The control voltage rises and falls with the overall volume of the input signal. This control signal can be routed to modulate the filter and also to a two other modulation destinations of your choice. For more information, please see "6.2 MODULATION" on page 16. Tightly coupled with the Envelope Follower is also an Envelope Generator. If you do not want to use the follower output directly, you can choose to use the follower only to trigger the Envelope Generator, if you want to use predefined Attack/Decay (or Attack/Release) times rather than follow the audio with the rise/fall slopes. For more information, please see "4.2 MODULATION SIGNAL FLOW" on page 12.

7.4.1 MODE

Sets the mode of the envelope follower. Turn the knob to access the next mode. The higher the value under the selected mode, the more gain is added to the signal, which is useful for weak input signals.

- **AR (Attack-Release)**

Creates an envelope control signal where the Attack phase begins when the incoming sound exceeds the threshold. The envelope then holds until the incoming sound falls under the threshold and the release phase starts

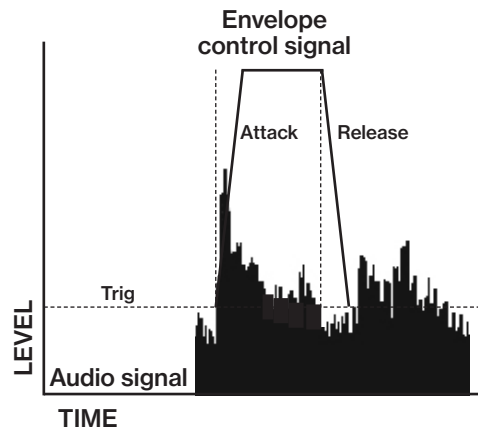

- **AD (Attack-Decay)**

Creates an envelope control signal where the Attack phase begins when the incoming sound exceeds the threshold and is then followed directly by the decay phase.

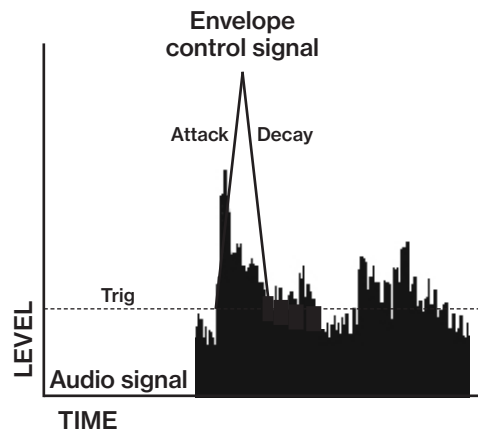

- **FLW (Follow)**

The envelope follows the amplitude of the input signal when it is above the threshold level.

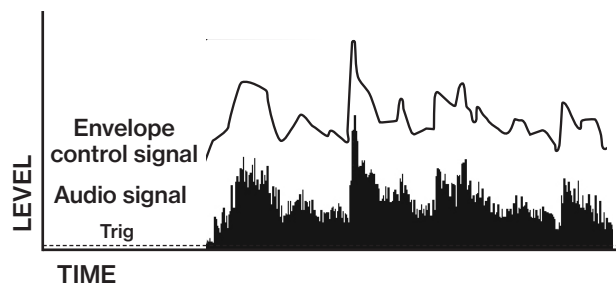

7.4.2 ATK

In Follow (FLW) mode, this is the rise time of the envelope follower, i.e. how quickly the follower rises when the amplitude of the audio increases. In generator mode (AD or AR), this is the attack time of the generated envelope. The rise time of the underlying envelope follower is set to fastest possible rise time in these configurations. (0-127)

7.4.3 REL

In Follow (FLW) mode, this is the fall time of the envelope follower, i.e. how quickly the follower falls when the amplitude of the audio falls. In generator mode (AD or AR), this is the decay- or release time of the generated envelope. The fall time of the underlying envelope follower is set to a good, predefined fall time in these configurations. (0-127)

7.4.4 TRIG

Sets the threshold level at which the envelope follower triggers the envelope generator and the LFO. (0.00–127.00)



Press [YES] + [ENV] to trigger the envelope generator manually. You can also send a gate signal to the Analog Heat MKII Control In inputs to trigger the envelope generator. For more information, please see "6.4 CONTROL IN" on page 18.

7.5 ENVELOPE PAGE 2

Press [ENV] twice to access this parameter page.

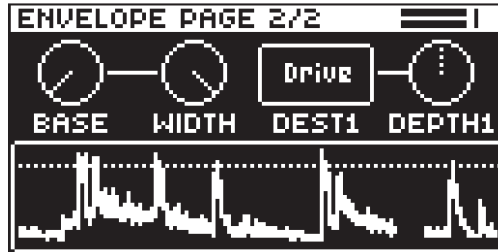

The envelope has three modulation destinations.

1. The first destination is set using the parameter **DEST1**. **DEPTH1** controls the amount of envelope modulation sent to the chosen destination. The first destination can also be set in the MODULATION parameter page found at SETTINGS > MODULATION. Select **ENV 1ST** as a source and then select modulation destination and modulation depth. For more information, please see "6.2 MODULATION" on page 16.
2. The second destination is set in the MODULATION parameter page (see above). Select **ENV 2ND** as a source and then select modulation destination and modulation depth.
3. The third modulation destination is permanently set to the filter cutoff. The parameter **ENV** on the FILTER/EQ PAGE 1 parameter page controls the amount of envelope modulation added to the filter cutoff.

The envelope follower uses a filter to define the frequency span of the input signal that the envelope follower reacts to. This span is defined by the **BASE** and **WIDTH** parameters.

Examples of how the **BASE** and **WIDTH** parameters affect the filter of the envelope follower:

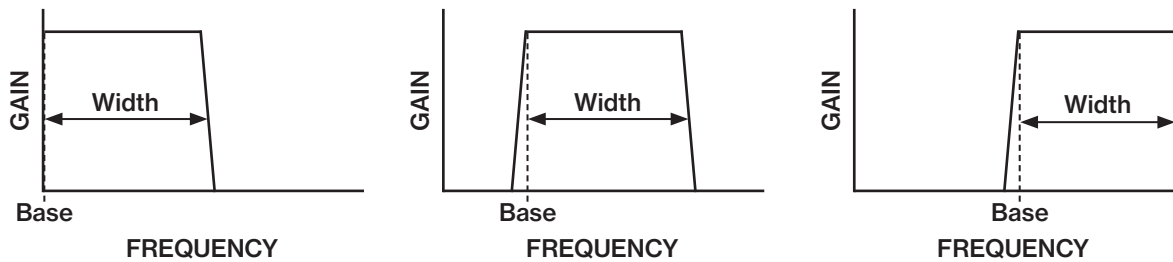

With **BASE** set to 0, the envelope follower filter functions as a low pass filter with **WIDTH** adjusting the frequency range.
 With **WIDTH** set to 127, the envelope follower filter functions as a high pass filter with **BASE** adjusting the frequency range.
 If you want the envelope follower to trigger specifically on different types of drums in a loop (for example the snare, or the hi-hats), this filter is very usable to isolate these elements.

7.5.1 BASE

Sets the base frequency of the filter detection. (0–127)

7.5.2 WIDTH

Sets the frequency width above the base frequency. (0–127)

7.5.3 DEST1

Sets the modulation destination of the envelope follower. For more information, please see "APPENDIX B: MODULATION SOURCES AND DESTINATIONS" on page 32.

7.5.4 DEPTH1

Sets the amount of how much the envelope follower affects the modulation destination. A negative value gives an inverted modulation. (-128.00→+127.00)

7.6 LFO PAGE 1

Press [LFO] once to access this parameter page.

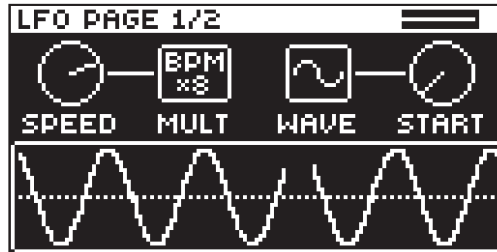

7.6.1 SPEED

Sets the rate of the LFO in relation to the internal or external tempo. It is synced to BPM if one of the "BPM x" settings are selected in the MULT parameter. To sync the LFO to straight beats, try settings of 16 or 32. The value of this parameter is bi-polar. (The LFO shape can be played backward by using negative values.) For more information, please see "6.3.1 INTERNAL TEMPO" on page 17. (-64–63)

7.6.2 MULT

Multiplies the SPEED parameter by the set factor. (x) multiplies the current BPM. 1-2K multiplies the LFO speed regardless of the current internal or external tempo.

7.6.3 WAVE

Sets the LFO waveform. (TRI, SINE, SQR, SAW, EXP, RAMP, RND)

7.6.4 START

Sets wherein the LFO waveform cycle it starts when triggered. (0–127) For example, if you set WAVE to SAW and START to 64 it starts at the middle of the wave cycle:

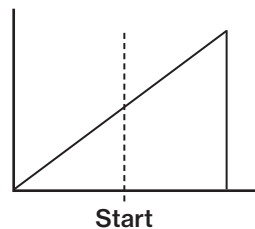

7.7 LFO PAGE 2

Press [LFO] twice to access this parameter page.



The LFO has three modulation destinations.

1. The first is set using the parameter **DEST1**. The amount of LFO modulation added to the selected destination is controlled by the parameter **DEPTH1**. The first modulation destination can also be set in the MODULATION parameter page found at SETTINGS>MODULATION. Select LFO 1ST as a source and then select modulation destination and modulation depth. For more information, please see "6.2 MODULATION" on page 16.

2. The second destination is set in the MODULATION parameter page (see above). Select LFO 2ND as a source and then select modulation destination and modulation depth.
3. The third modulation destination is permanently set to the filter cutoff. The amount of LFO modulation added to the filter cutoff is controlled by the parameter **LFO** on the FILTER/EQ PAGE 1 parameter page.

7.7.1 FADE

FADE offers the possibility to fade in/out the LFO modulation. Positive values give a fade-out, negative values give a fade-in. A middle position (0) results in no fade in/out. The fade curve is restarted each time the LFO triggers. For more information, please see "7.4.4 TRIG" on page 24. (-64–63)

7.7.2 MODE

Selects between four different modes of LFO behavior.

- **FREE** is the default free-running mode. The LFO run continuously, never restarting or stopping.
- **TRIG** The LFO run continuously, but restarts on the event of an envelope trig.
- **HOLD** The LFO run continuously, but on the event of an envelope trig, the output LFO level is latched and held still until the next envelope trig
- **ONE** The LFO does nothing until the event of an envelope trig. It then runs for one complete cycle and then stops. This setting makes the LFO function similar to an envelope.
- **HALF** The LFO does nothing until the event of an envelope trig. It then runs for a one-half cycle and then stops.

7.7.3 DEST1

Sets the modulation destination of the LFO. For more information, please see "APPENDIX B: MODULATION SOURCES AND DESTINATIONS" on page 32.

7.7.4 DEPTH1

Sets the amount of how much the LFO affects the modulation destination. A negative value gives an inverted modulation. (Range -128.00–127.00.)

8. TIPS & TRICKS

Here you can find a couple of different examples of some of the things you can do with the Analog Heat MKII.

8.1 ADDING SATURATION TO THE HIGH REGISTER

You can use the Analog Heat MKII to add saturation to the high-frequency register of a full range mix. This is useful when you want to introduce some subtle harmonics to the mix, without distorting the overall sound.

1. Select the **SATURATION** circuit and the **HIGH PASS 2** filter.
2. Connect your sound source to the Analog Heat MKII and make sure that the volume of the sound source is as strong as possible.
3. Make sure the input level is correctly set. For more information, please see "3.2 SETTING THE INPUT SENSITIVITY LEVEL" on page 10.
4. Start by setting **DRIVE** to 0, **WET LEVEL** to 127, and **DRY/WET** to 0. Set the filter **RESONANCE** to 0 and **FREQUENCY** to 100.
5. Increase **DRIVE** until you start to hear a little saturation in the higher registers, but not so much that the saturation gets too dominant. The processed signal is lower than the bypassed signal, so you should adjust the preset volume (For more information, please see "7.1.4 VOL" on page 21.) to match the active and bypassed state to be able to A/B test correctly.
6. Tweak **DRY/WET** and **DRIVE** until you find a nice balance and the sound you want. If you want to use the EQ, remember that only **HIGH EQ** affects the sound, since the low frequencies are filtered out.

8.2 PSEUDO-COMPRESSION

You can use the Analog Heat MKII to emulate a compressor and/or expander by using the Envelope Generator. This is useful if you want to add some extra pump to drums, or to liven up a flat sound. In this example, you should use a highly dynamic sound source, with sharp transients, such as drums.

1. Select the **CLEAN BOOST** circuit and disable the filter by pressing both **[FILTER TYPE]** keys at the same time. All filter type LEDs should be turned off.
2. Connect your sound source to the Analog Heat MKII and make sure that the volume of the sound source is as strong as possible.
3. Make sure the input level is correctly set. For more information, please see "3.2 SETTING THE INPUT SENSITIVITY LEVEL" on page 10.
4. Start by setting **DRIVE** to 0, **WET LEVEL** to 127, and **DRY/WET** to 127.
5. Press the **[AMP]** key to access AMP PAGE, and set **VOL** to 127.
6. Press the **[ENV]** key to access ENVELOPE PAGE 1, and set **MODE** to AD. Adjust the **MODE (AD)** parameter until you clearly see the incoming signal in the **TRIG** meter. You should see the peaks and dips of the incoming signal, retaining as much as possible of dynamics of the signal.
7. Lower the **TRIG** value until you see the trigger icon blink in the upper right corner of the screen. Make sure it triggers mainly from the strongest peaks of the incoming sound.
8. Set **ATK** to 48, and **REL** to 72.

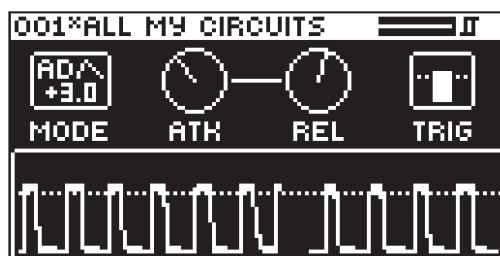

9. Press **[ENV]** a second time to access ENVELOPE PAGE 2 and change **DEST1** to PRESET VOL and **DEPTH1** to -72.

You should now hear a very dynamic ducking effect with pretty sharp transients. You can change **VOL**, **ATK**, **REL**, and **DEPTH1** to achieve different compression effects.

If you change **VOL** to 80 and apply positive modulation (**DEPTH1**), you expand the signal instead of compress it.

Bonus: Adding LFO

1. Press the **[LFO]** key to access LFO PAGE 1.
2. Set **WAVE** to SQR, **SPEED** to 1, and **MULT** to x1.
3. Press the **[LFO]** key again to access LFO PAGE 2.
4. Set **DEST1** to PRESET VOL, **MODE** to TRI, and **FADE** to 40.
5. Apply positive modulation from **DEPTH1** for even louder transients.

Note that **DEPTH1** on ENVELOPE PAGE 2 need to be lowered to make room for the LFO modulation.

8.3 STEREO PHASER EFFECT

The Analog Heat MKII can also achieve an effect similar to that of a classic stereo phaser pedal by using the filter frequency panning function.

1. Select any circuit and set the **[FILTER TYPE]** to BAND STOP.
2. Connect your sound source to the Analog Heat MKII and make sure that the volume of the sound source is as strong as possible.
3. Make sure the input level is correctly set. For more information, please see "3.2 SETTING THE INPUT SENSITIVITY LEVEL" on page 10.
4. Start by setting **WET LEVEL** to 127, and **DRY/WET** to 63. Set **FREQUENCY** to 64, and **RESONANCE** to 0.
5. Press the **[LFO]** key twice to access LFO PAGE 2, and change **DEST1** to FILTER PAN and set **DEPTH1** to around +64.
6. Press the **[LFO]** key to access LFO PAGE 1 and set **SPEED** to your liking.

You should now hear a phasing effect applied to your sound. Try playing around with the LFO waveforms, speed, and depth, as well as the filter frequency. The different Filter Types have a different impact on the sound when you use the filter frequency panning.

9. STARTUP MENU

To access this menu, hold down the [ON] key while powering up the Analog Heat MKII. From here you can perform a variety of tasks.

9.1 TEST MODE

To enter this mode, press the [AMP] key.



Remember to turn down the volume on all speakers and headphones before activating Test mode. For testing purposes, a short sound is heard through all outputs of the Analog Heat MKII.

If you have any trouble with your Analog Heat MKII and suspect it may be due to a hardware problem, perform this self-test. Use the **PRESET/DATA** knob to scroll through the test log. A fully functional device should not report any errors. If it does report an error, please contact Elektron support or the retailer that you bought your Analog Heat MKII from.

9.2 EMPTY RESET

To perform an empty reset, press the [FLTR & EQ] key. This will reset the device and erase all presets.

9.3 FACTORY RESET

To perform a factory reset, press the [ENV] key. This will reset the device and overwrite preset 001–016 with factory presets. The remaining preset slots will be empty.

9.4 OS UPGRADE

Initiate the OS upgrade by pressing the [LFO] key. Analog Heat MKII will enter a waiting stage, listening for incoming OS data, and “READY TO RECEIVE” will be shown on the screen. For the transfer to be possible, the device sending the OS syx file must be connected to the MIDI IN port of the Analog Heat MKII. To send the OS syx file, use our free SysEx utility software C6. The OS syx file and the C6 software can be downloaded from the Elektron website.



USB MIDI transfer is not possible when you upgrade the OS from the STARTUP MENU.

On your computer, download the OS syx file, open the C6 software. Click CONFIGURE and select the device you want to use to transfer the syx file (usually your sound card) for MIDI In as well as MIDI Out. Drag the syx file to the C6 main window, then highlight it by clicking it with the mouse pointer. Press “Send” in the top left corner of the C6 window.

As the Analog Heat MKII receives the OS, a progress bar will show how much of the OS has been received. When the transfer is finished the message “UPGRADING... DO NOT TURN OFF” appears. The device will restart when the upgrade process is finished.



- When you send the OS syx file, use our free Elektron C6 software. You can download it from the Elektron website.
- If the Analog Heat MKII receives the OS upgrade through the MIDI ports, you can use the Elektron TM-1 USB MIDI interface for up to 10x transfer speeds.

10. TECHNICAL INFORMATION

ELECTRICAL SPECIFICATIONS

Impedance balanced audio outputs
Main outputs level: +19 dBu
Output impedance: 440 Ω unbalanced

Headphones output
Headphones out level: +19 dBu
Output impedance: 36 Ω

Balanced audio inputs
Input level: +19 dBu peak
Audio input impedance: 39 k Ω

Control inputs
Input level on tip: -5 V–+5 V. Supplies +5 V on ring
Accepts CV, Expression pedals, Footswitches

Unit power consumption: 12 W typical
Compatible Elektron power supply: PSU-3b

HARDWARE

128 × 64 pixel OLED screen
MIDI In/Out/Thru with DIN Sync out
2 × 1/4" impedance balanced audio out jacks
2 × 1/4" balanced audio in jacks
1 × 1/4" stereo headphone jack
2 × 1/4" control input jacks
48 kHz, 24-bit D/A and A/D converters
Electrically isolated Hi-speed USB 2.0 port
Power inlet: Center positive 5.5 × 2.5 mm barrel jack,
12 V DC, 2 A

PHYSICAL SPECIFICATIONS

Sturdy steel casing
Dimensions: W 215 × D 184 × H 63 mm (8.5" × 7.2" × 2.5") (including power switch, jacks, knobs and feet)
Weight: approximately 1.5 kg (3.3 lbs)
100 × 100 mm VESA mounting holes. Use M4 screws with a max length of 7.4 mm.
Maximum recommended ambient operating temperature: +35 °C (+96 °F)

11. CREDITS AND CONTACT INFORMATION

CREDITS

PRODUCT DESIGN AND DEVELOPMENT

Oscar Albinsson
Johannes Algelind
Ali Alper Çakır
Magnus Forsell
Anders Gärder
Andreas Henriksson
Simon Mattisson
Jimmy Myhrman
Jon Mårtensson
Viktor Nilsson
Olle Petersson
David Revelj
Mattias Rickardsson
Martin Sigby

ADDITIONAL DESIGN

Johan Damerou
Ufuk Demir
Thomas Ekelund
Olle Petersson
Cenk Sayinli

DOCUMENTATION

Erik Ångman

CONTACT INFORMATION

ELEKTRON WEBSITE

<http://www.elektron.se>

OFFICE ADDRESS

Elektron Music Machines MAV AB
Sockerbruket 9
SE-414 51 Gothenburg
Sweden

TELEPHONE

+46 (0)31 743 744 0

APPENDIX A: MIDI

This appendix lists the CC and NRPN numbers for the Analog Heat MKII.

Parameter	CC MSB	CC LSB	NRPN MSB	NRPN LSB	Specific values info
Circuit Select	70		0	70	0=CB, 1=SA, 2=EN, 3=MD, 4=RC, 5=CD, 6=RF, 7=HG
Drive	12	37	0	12	
Wet Level	11	38	0	11	
Dry/wet Mix	8	39	0	8	
Preset Volume	7		0	7	
EQ Low	9	40	0	9	
EQ High	10	41	0	10	
VCF Mode	80		0	80	1=LP2, 3=LP1, 5=BP, 7=HP1, 9=HP2, 11=BS, 13=PK
VCF Frequency	74	42	0	74	
VCF Frequency Pan	79	49	0	79	
VCF Resonance	71	43	0	71	
VCF Dirt	13		0	13	
ENV to Filter	14	44	0	14	
LFO to Filter	15	45	0	15	
ENV Threshold	16	46	0	16	
ENV Attack	73		0	73	
ENV Release	72		0	72	
ENV Base	17		0	17	
ENV Width	18		0	18	
ENV Mode	19		0	19	
ENV Destination	75		0	75	
ENV Depth	20	47	0	20	
ENV Destination 2	76		0	76	
ENV Depth 2	21		0	21	
LFO Waveform	83		0	83	0=TRI, 1=SIN 2=SQR, 3=SAW, 4=EXP, 5=RAMP, 6=RND
LFO Speed	22		0	22	
LFO Multiplier	23		0	23	
LFO Fade	24		0	24	
LFO Mode	25		0	25	0=FREE, 1=TRIG, 2=HOLD, 3=ONE, 4=HALF
LFO Start Phase	26		0	26	
LFO Destination	77		0	77	
LFO Depth	27	48	0	27	
LFO Destination 2	78		0	78	
LFO Depth 2	28		0	28	
CV A Destination	85		0	85	
CV A Depth	86		0	86	
Expr. A Destination	87		0	87	
Expr. A Depth	88		0	88	
CV B Destination	89		0	89	
CV B Depth	90		0	90	
Expr. B Destination	91		0	91	
Expr. B Depth	92		0	92	

APPENDIX B: MODULATION SOURCES AND DESTINATIONS

This appendix lists parameters that can be modulated by one or more of the following modulation sources; Envelope/Envelope Follower, LFO, and Expression pedal/CV.

Parameter	Modulation source		
	ENV	LFO	EXP/CV
Drive	X	X	X
Wet Level	X	X	X
Dry/Wet Mix	X	X	X
Preset Volume	X	X	X
EQ Low	X	X	X
EQ High	X	X	X
VCF Frequency	X	X	X
VCF Frequency Pan	X	X	X
VCF Resonance	X	X	X
VCF Dirt	X	X	X
ENV to VCF		X	X
LFO to VCF	X	X	X
ENV Trig Level			X
ENV Attack			X
ENV Release			X
ENV Base			X
ENV Width			X
ENV Destination			X
ENV Depth			X
ENV Destination 2			X
ENV Depth 2			X
LFO Waveform	X		X
LFO Speed	X		X
LFO Multiplier	X		X
LFO Fade	X		X
LFO Mode	X		X
LFO Start	X		X
LFO Destination	X		X
LFO Depth	X		X
LFO Destination 2	X		X
LFO Depth 2	X		X

INDEX

A**ACTIVE MODE 13****AMPLIFIER 20**

- Drive 20
- Dry/Wet 20
- Volume 20
- Wet 20

AUDIO & ROUTING 16**C****CALIBRATION 19****CONNECTIONS 9****CONTROL INPUTS 17****CREDITS AND CONTACT INFORMATION 28****CV 17****E****EFFECT CIRCUITS 13****ENVELOPE (FOLLOWER) 21**

- Attack 22
- Base 23
- Filter 23
- Mode: Attack-Decay 22
- Mode: Attack-Release 22
- Mode: Follow 22
- Modulation depth 24
- Modulation destination 23
- Release 23
- Trigger 23
- Width 23

EQUALIZER 21

- EQ High 21
- EQ Low 21

EXPRESSION PEDAL 17**F****FACTORY RESET 27****FILTER**

- Dirt 21
- Env modulation 21
- Frequency 20
- Frequency panning 21
- LFO modulation 21
- Resonance 21

FOOTSWITCH 17**I****INPUT LEVEL**

- Input sensitivity 15
- Setting 10

L**LCD SCREEN 14****LFO 24**

- Fade 25
- LFO Tempo 16
- Mode 25
- Modulation depth 25
- Modulation destination 25
- Multiplier 24

- Phase 24
- Speed 24
- Waveform 24

M**MIDI 18**

- CC, NRPN specification 29
- Ports 18
- Sync 18

MODULATION SOURCES/DESTINATIONS 30**O****OS UPGRADE 19****OVERBRIDGE 15****P****PANEL LAYOUT AND CONNECTIONS**

- Connecting the unit 10
- Front panel 8
- Rear panel 9

PARAMETER EDITING 14**PARAMETER PAGES 14****PARAMETERS 20**

- Amp 20
- Envelope follower 21
- EQ 21
- Filter 20
- LFO 24

PRESETS 12

- Loading a preset 12
- Preset volume 20
- Saving a preset 13

S**SAFETY AND MAINTENANCE 3****SETTINGS MENU**

- Audio 15
- Audio & Routing 16
- Control in 17
- Input sensitivity 15
- MIDI 18
- Options 16
- System 19

SETUP EXAMPLES 11**SIGNAL FLOW 12**

- Audio signal flow 12
- Modulation signal flow 12

STARTUP MENU 27**SYSTEM 19**

- Calibration 19
- OS Upgrade 19
- USB config 19

T**TECHNICAL INFORMATION 28****TEST MODE 27****TIPS & TRICKS 25****U****USER INTERFACE 12**

